

L&W MACHINE

● *Vertical Machining Center*

JHV *Linear Ways Series*



A Competitive Performer for Precision Mold and 3C Parts Machining!

In today's competitive environment, the only way for competitive edge is pursue efficiency and quality, Cyclone high speed JHV series are just designed and engineered with high efficiency and high accuracy in mind. The JHV series employs high speed spindle, linear ways on three axes and rigid machine structure. When it comes to precision parts, mold and 3C parts machining, the Cyclone high speed VMC is your only choice.

JHV-1300, 1500

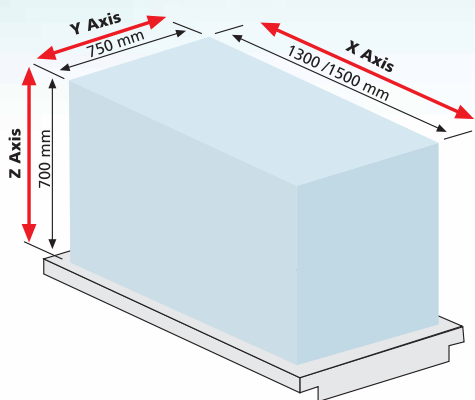

on Parts,



JHV-850, 1020 |



Optimal Structure Design

High Rigidity! Lifetime Stability!

- *The major structures are manufactured from Meehanite cast iron. stress relieved combined with scientific rib reinforcement to ensure deformation-free.*
- *Increased width on the column bottom with box-type structure provides maximum stability especially when performing high speed cutting.*
- *Linear ways on three axes assure high feed rates and extremely smooth motion.*
- *Extra wide span between linear ways greatly increases machine stability.*



JHV-850, 1020 |

- Choice of 8,000, 10,000, 12,000 or 15,000 rpm high spindle speed is designed for high speed machining requirement.
- High precision class C3 ball screws feature outstanding vibration dampening capability for high precision machining.
- Extra wide column bottom and base ansure superior stability during high speed machining.
- Compacted and simplified machine structure for space saving.
- Increased Y-axis travel for increased working capacity (models JHV-1300/1500)

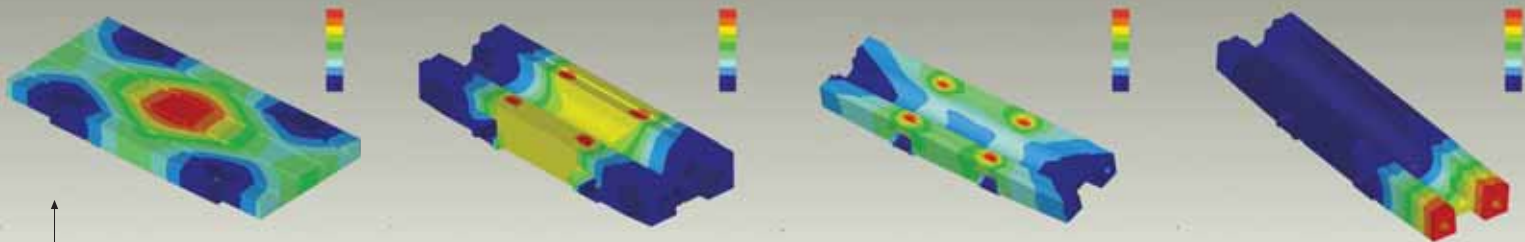

Finite Element Analysis

The structural parts on Cyclone machine are analyzed and designed by the advanced Finite Element Analysis. It provides a detailed analysis for structural stress/strain conditions, and ensures excellent machine rigidity and lifetime stability.



Linear Guide Way

The machine employs 45 mm, wide ball-type linear guide ways.



Precision ball Screw

Three axes are transmitted by high precision ball screws, preloaded, hardened and ground, assuring dependable feed accuracy.

JHV-1300, 1500 |

Choice of Various High Speed Spindle



Belt Drive Spindle

- Choice of spindle 8,000 / 10,000 / 12,000 rpm.
- Spindle taper BT-40.



Direct Drive Spindle

- Choice of spindle speeds 10,000 / 12,000 / 15,000 rpm
- Spindle taper BT-40.



Carousel Type Magazine

The carousel type magazine is standard equipment. It carries 16 tools for various types of machining applications. Fixed type tool selection for quick tool changing that reduces non-cutting time.



Arm type Magazine (Optional)

The magazine is driven by a precision cam for rapid and stable tool change motion. Tool loading capacity provides 20 or 24 tools to choose from. Bi-directional random tool selection provides quick tool changing that reduces non-cutting time.



Directly Coupled Servomotors

The three axes ball screws are directly coupled to servomotors through backlash-free couplings. This ensures dependable positioning accuracy. High precision class C3 ball screws are preloaded to eliminate thermal strain.



Heat Exchanger for Control Cabinet

To maintain a constant temperature inside the control cabinet, the machine is equipped with a heat exchanger, it provides effective protection for the controller and electronic components. The high performance heat. exchanger features high efficiency heat exchanger and power saving.



Spindle Oil Cooler

It prevents spindle thermal deformation due to oil temperature variation while ensuring high machining accuracy, especially at high spindle speeds.



Convenient Workpiece Loading

The shortened distance between the table and the front of the machine provides easy accessibility for workpiece loading and unloading.



Ball Bar Test

Through ball bar testing, geometry error and backlash can be accurately obtained allowing the machine to be adjusted to the best possible accuracy.

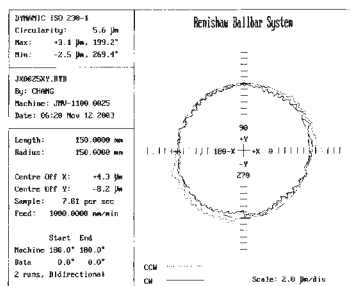

Laster Inspection

An advanced laser instrument is employed for inspecting and compensating linear accuracy and pitch error, this assures optimum axis travel accuracy.

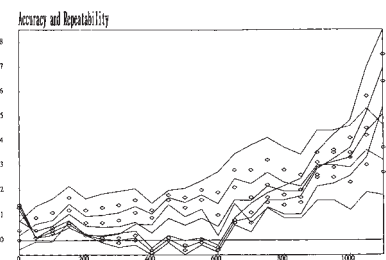

Look to Cyclone High Speed VMC for Better Efficiency

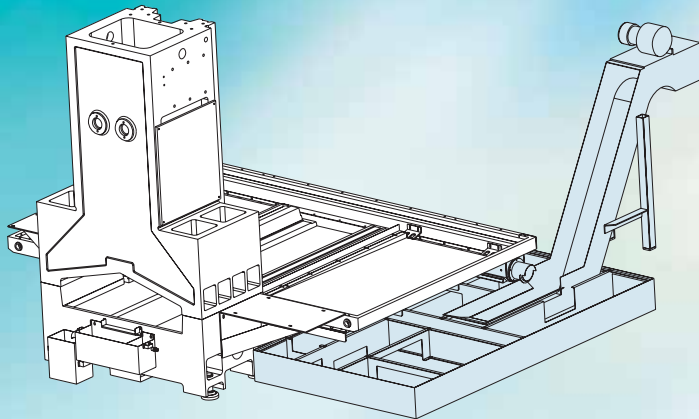

Front Mounted Link-Chain-Type Chip Conveyor

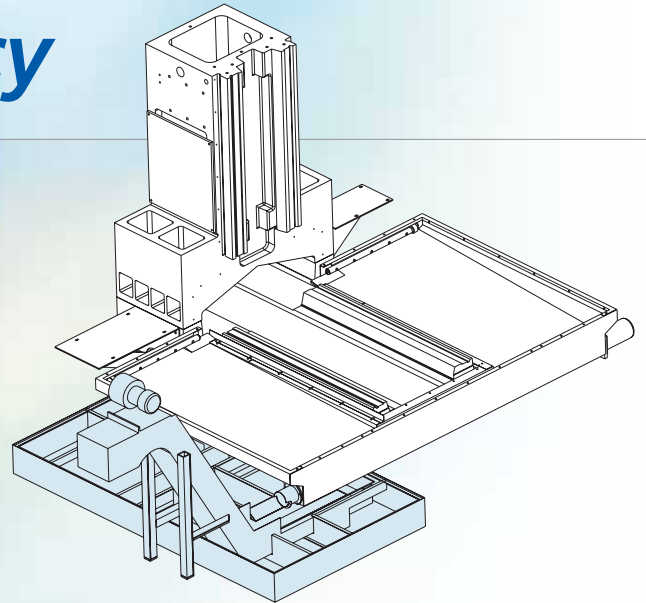

Side Mounted Link-Chain Type Chip Conveyor

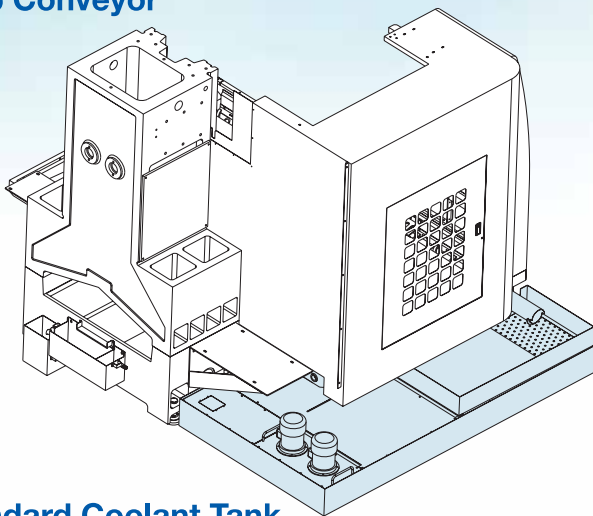



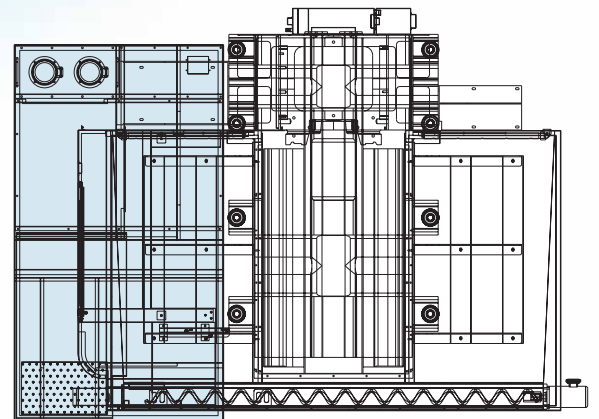

Standard Coolant Tank

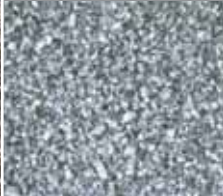

Front Mounted Screw-Type Chip Conveyor

Chip Conveyor Selection Table

Chip Types	Metal Chips	Cast Iron Chips	Curied Alumium Chips	Curied Alumium Chips	Non-fereous Chips
Workpiece Material					
Link-Chain-Type Chip Conveyor	✓	✓	✓	✓	✓
Screw-Type Chip Conveyor	✓		✓	✓	

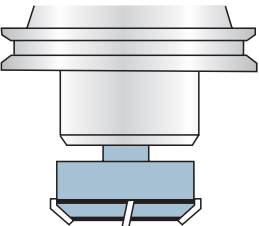
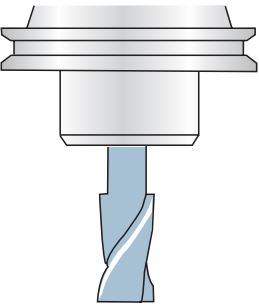
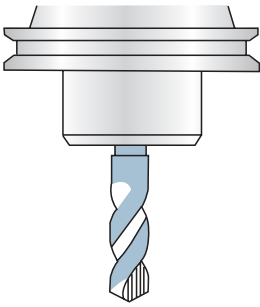
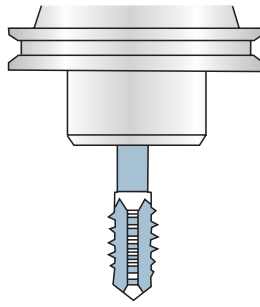

Superior Cutting Capabilities

			
Face Milling	End Milling	Drilling	Tapping
Ø80 S:1000 RPM D:3 mm 320 cc/min	Ø50 S:1800 RPM D:10 mm	Ø21 S:300 RPM D:50 mm	M20 S:100 RPM D:30 mm



Coolant Flushing Device (Optional)

Three coolant nozzles are provided on both sides of the table featuring high pressure flushing to remove chips from the tables.



4TH / 5TH CNC Rotary Table (Optional)

The 4th/5th CNC rotary table features high positioning accuracy and maximum stability during cutting. It is ideal for various types of workpiece machine.



Spindle Flood Coolant (Optional)

The spindle flood coolant is available only for models with arm-type magazine. The device not only effectively removes chips on workpiece but also increases workpiece cooling efficiency.

Vertical Machining Center

JHV Series

Specification :

MODEL	Unit	JHV-850		JHV-1020	
TRAVEL		Linear		Linear	
X-axis travel	mm	850		1020	
Y-axis travel	mm	550		550	
Z-axis travel	mm	580		580	
Spindle nose to table	mm	120-700		120-700	
TABLE					
Table area	mm	1020 x 550		1200 x 550	
Max. load of table	kg	600		800	
T-slot (number x width x pith)	mm	4 x 18 x 125		4 x 18 x 125	
SPINDLE		8000 RPM (Standard)			
Spindle taper		BT-40	BT-40	BT-40	BT-40
Spindle speed	rpm	8000, 10000, 12000	10000, 12000, 15000	8000, 10000, 12000	10000, 12000, 15000
Transmission		Belt type	Direct type	Belt type	Direct type
Spindle motor	kw	5.5 / 7.5	5.5 / 7.5	7.5 / 11	7.5 / 11
Spindle cooling		Oil cooler		Oil cooler	
FEED RATE					
Rapid traverse (X, Y, Z)	M/min	30 / 30 / 20		30 / 30 / 20	
Cutting feed rate	mm/min	1-15000		1-15000	
3 Axes motor output (X,Y,Z)	kw	1.8 / 1.8 / 2.5		1.8 / 1.8 / 2.5	
ATC					
Magazine type		Carousel	Arm	Carousel	Arm
Tool magazine capacity	pcs	16	24	16	24
Max. tool diameter	mm	100 / 150	80 / 150	100 / 150	80 / 150
Max. tool length	mm	250	250	250	250
Max. tool weight	kg	7	7	7	7
Tool selection		Fixed type	Random	Fixed type	Random
OTHER					
Power consumption	KVA	20		20	
Floor space (L x W x H)	mm	2940 x 2180 x 2350		2940 x 2180 x 2350	
Machine weight	kg	6200		6800	

• L&W Machine Tools, Inc. reserves the right to alter any mechanical specification without prior notice in the interest of product development.



JHV-1300		JHV-1500	
Linear		Linear	
1300		1500	
750		750	
700 (750 opt.)		700 (750 opt.)	
120-820		120-820	
1420 x 750		1650 x 750	
1000		1000	
5 x 18 x 125		5 x 18 x 125	
8000 RPM (Standard)			
BT-40	BT-40	BT-40	BT-40
8000. 10000. 12000	10000. 12000. 15000	8000. 10000. 12000	10000. 12000. 15000
Belt type	Direct type	Belt type	Direct type
7.5 / 11	7.5 / 11	7.5 / 11	7.5 / 11
Oil cooler		Oil cooler	
30 / 30 / 24		30 / 30 / 24	
1-15000		1-15000	
4.0 / 4.0 / 7.0		4.0 / 4.0 / 7.0	
Carousel	Arm	Carousel	Arm
16	24	16	24
100 / 150	80 / 150	100 / 150	80 / 150
300	300	300	300
7	7	7	7
Fixed type	Random	Fixed type	Random
40		40	
3720 x 2840 x 2810		4100 x 2840 x 2810	
10000		11000	

Standard Accessories:

- Full splash guard.
- Cutting coolant unit.
- Heat exchanger in control cabinet.
- Auto power off.
- Auto lubrication system.
- Air blast through spindle.
- Work lamp.
- Tool box.
- Armless (carousel) type ATC (16 tools).
- Rigid tapping.
- Operation manual for machine and controller.
- RS-232 interface.
- Screw type chip conveyor.
- Spindle speed in 8,000 rpm with oil cooler.

Optional Accessories:

- Direct drive spindle 10,000, 12,000 or 15,000 RPM.
- Belt drive spindle 10,000 or 12,000 RPM.
- Rotary table 320 or 250 (4th axis; including manual tailstock, oil tank, motor and driver).
- Arm-type ATC (24 tools).
- Oil Skimmer.
- Coolant gun (motor).
- Rear coolant flushing device.
- Link-chain-type chip conveyor.
- Coolant through tool holder.
- Spindle flood coolant (available for modles with arm-type ATC).
- Linear scales for 3 axes.
- Coolant through spindle with filter.
- Deep hole drilling stop.
- Auto tool probe.

JHV

Linear Ways Series



L&W MACHINE TOOLS, INC.

Factory: No. 53, Ho Tso St., Feng Yuan, Taichung Hsien, Taiwan

Export Office: 9F-8, No.62, Ta Ya Road, Taichung, Taiwan

Tel : +886-4-2201-4701 Fax: +886-4-2203-6013, 2207-0371

<http://www.lw-machinetools.com> • E-mail: lwmachin@ms31.hinet.net