



Yung Ji

高速精密刀桿系列 High Speed Precision Collet Chucks Series

■ 適用範圍：

- 一般銑削/鑽孔加工
- 高精度銑削/鉸孔加工
偏擺精度： $\leq 0.005\text{mm}$.
使用高速全圓螺帽
動平衡等級： $\leq G2.5/30.000\text{RPM}(\text{BT30})$
 $\leq G2.5/25.000\text{RPM}(\text{BT40})$

■ Application:

- General milling/drilling.
- High precision milling/reaming
Run-out Precision： $\leq 0.005\text{mm}$.
Use High speed round nut
Balanced Grade： $\leq G2.5/30.000\text{RPM}(\text{BT30})$
 $\leq G2.5/25.000\text{RPM}(\text{BT40})$



SK 高速精密筒夾刀桿 BT30 / BT40 High Speed Precision Collet Chuck BT30/ BT40



▶ BT40

▶ BT30

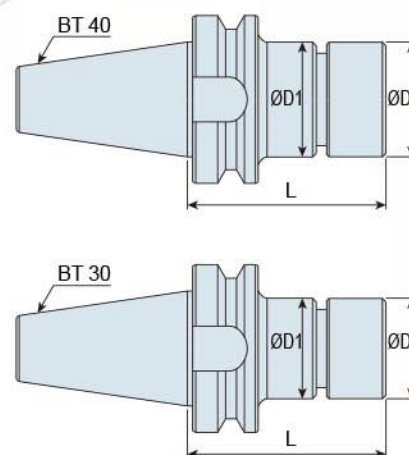

訂購編號 Order No.	Fig	夾持範圍 Range	ØD	ØD1	L	螺帽 Nut	板手 Wrench
BT30-SK10-045G	1	Ø2-10	30	30	45	SK10G	SK10G
BT30-SK10-060G					60		
BT30-SK10-090G					90		
BT30-SK10-130G					130		
BT30-SK13-060G	1	Ø3-13	35	35	60	SK13G	SK13G
BT30-SK13-075G					75		
BT30-SK13-090G					90		
BT30-SK13-130G					130		
BT30-SK16-060G	1	Ø3-16	40	40	60	SK16G	SK16G
BT30-SK16-090G					90		
BT30-SK16-130G					130		
BT30-SK20-060G	1	Ø3-20	50	50	60	SK20G	SK20G
BT30-SK20-090G					90		
BT30-SK25-090G			Ø4-25	55	55	90	SK25G
BT40-SK10-060G	1	Ø2-10	30	30	60	SK10G	SK10G
BT40-SK10-090G					90		
BT40-SK10-120G					120		
BT40-SK10-150G	2				150		
BT40-SK10-165G					165		
BT40-SK10-200G					200		
BT40-SK13-060G	1	Ø3-13	35	35	60	SK13G	SK13G
BT40-SK13-090G					90		
BT40-SK13-120G					120		
BT40-SK13-150G	2				150		
BT40-SK13-165G					165		
BT40-SK13-200G					200		
BT40-SK16-060G	1	Ø3-16	40	40	60	SK16G	SK16G
BT40-SK16-090G					90		
BT40-SK16-120G					120		
BT40-SK16-150G	2				150		
BT40-SK16-165G					165		
BT40-SK16-200G					200		
BT40-SK20-060G	1	Ø3-20	50	50	60	SK20G	SK20G
BT40-SK20-090G					90		
BT40-SK20-120G					120		
BT40-SK20-150G	2				150		
BT40-SK20-200G					200		
BT40-SK25-080G	1	Ø4-25	55	55	80	SK25G	SK25G
BT40-SK25-120G					120		
BT40-SK25-150G					150		
BT40-SK25-200G					200		

■ 特殊規格訂製。 Make to order for special specification.



SK 高速精密筒夾刀桿 BT50 High Speed Precision Collet Chuck BT50



▶ BT50

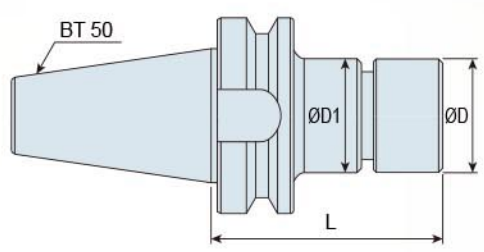

訂購編號 Order No.	Fig	夾持範圍 Range	ØD	ØD1	L	螺帽 Nut	板手 Wrench
BT50-SK10-105G	1	Ø2-10	30	30	105	SK10G	SK10G
BT50-SK10-135G					135		
BT50-SK10-150G	2				150		
BT50-SK10-165G					165		
BT50-SK10-200G	200						
BT50-SK13-105G	1				Ø3-13		
BT50-SK13-135G		135					
BT50-SK13-150G	2	150					
BT50-SK13-165G		165					
BT50-SK13-200G	200						
BT50-SK16-065G	1	Ø3-16	40	40		65	SK16G
BT50-SK16-105G					105		
BT50-SK16-135G	2				135		
BT50-SK16-150G					150		
BT50-SK16-165G	165						
BT50-SK16-200G	200						
BT50-SK16-250G	2	Ø3-20	50	50	250	SK20G	SK20G
BT50-SK16-300G					300		
BT50-SK20-105G	1				105		
BT50-SK20-135G					135		
BT50-SK20-150G	2				150		
BT50-SK20-165G					165		
BT50-SK20-200G		200					
BT50-SK20-250G		250					
BT50-SK20-300G	300						
BT50-SK25-105G	1	Ø4-25	55	55	105	SK25G	SK25G
BT50-SK25-135G					135		
BT50-SK25-150G	2				150		
BT50-SK25-165G					165		
BT50-SK25-200G	200						
BT50-SK25-250G	250						
BT50-SK25-300G	300						

■ 特殊規格訂製。 Make to order for special specification.



BT 直結式鑽夾頭 Chu CNC Drill Chucks



BT Shank JIS B 6339(MAS 403 BT)

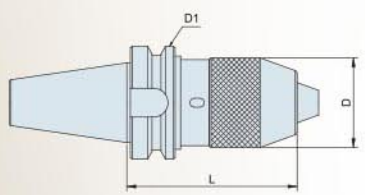

BT直結式鑽夾頭 Chu CNC Drill Chucks

訂購編號 Order No.	夾持範圍 Range	L	D	D	扳手編號 Spanner No.
BT01505	BT30xCHU8 - 75	75	37	46	12802
BT01510	BT30xCHU13 - 90	90	50		12806
BT01515	BT40xCHU8 - 85	85	37		12802
BT01525	BT40xCHU13 - 95	95	50	63	12806
BT01545	BT40xCHU16 - 120	120	57		12808
BT01550	BT50xCHU13 - 110	110	50	100	12806
BT01564	BT50xCHU16 - 110	110	57		12808

■ 特殊規格訂製。Make to order for special specification.

應用

- 傳統銑床或其他提供BT主軸介面之工作母機作鑽孔加工

Application

- The product can be adapted for the general lathe or the drilling processing whose machines center can supply with BT spindle.

特性

- 比普通夾頭多3倍的夾持力
- 鑽頭不會鬆脫或掉落
- 比普通夾頭多出2倍精準
- 可替換式的夾頭

Features

- 3 times better clamping capacity, comparing to keyed drill chucks.
- The drill bit won't be loosen or falling off.
- Twice precision than the keyed drill chucks.
- The drill chuck is interchangeable.



BT Shank JIS B 6339(MAS 403 BT)
with Collet Chuck DIN 6499

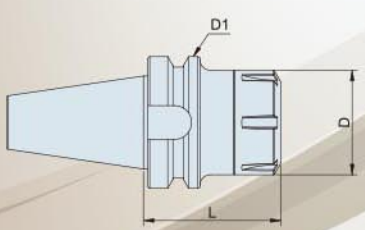

BT刀把 ER立銑式 BT ER Collet Chucks

訂購編號 Order No.	夾持範圍 Range	L	D	D	扳手編號 Spanner No.	
BT02005	BT30xER11 - 60	60	19	46	80072-01	
BT02015	BT30xER16 - 60	60	28		80072-02	
BT02025	BT30xER16 - 100	100	34		80072-03	
BT02040	BT30xER20 - 60	60			80072-04	
BT02050	BT30xER20 - 100	100	42		80072-05	
BT02060	BT30xER25 - 60	60	50			
BT02065	BT30xER25 - 100	100				
BT02080	BT30xER32 - 70	70	63	80072-01		
BT02085	BT30xER32 - 100	100				
BT02095	BT40xER11 - 70	70			19	80072-02
BT02100	BT40xER11 - 100	100				
BT02106	BT40xER16 - 70	70				
BT02110	BT40xER16 - 100	100	28	80072-03		
BT02131	BT40xER20 - 70	70				
BT02140	BT40xER20 - 100	100	34	80072-04		
BT02155	BT40xER25 - 70	70				
BT02165	BT40xER25 - 100	100	42	80072-05		
BT02185	BT40xER32 - 70	70				
BT02190	BT40xER32 - 100	100	50	80072-06		
BT02200	BT40xER40 - 70	70				
BT02205	BT40xER40 - 100	100	63	80072-07		
BT02220	BT40xER50 - 90	90				
BT02225	BT40xER50 - 100	100	78			

BT02095	BT40xER11 - 70	70	19	80072-01
BT02100	BT40xER11 - 100	100		
BT02106	BT40xER16 - 70	70		
BT02110	BT40xER16 - 100	100	28	80072-02
BT02131	BT40xER20 - 70	70		
BT02140	BT40xER20 - 100	100	34	80072-03
BT02155	BT40xER25 - 70	70		
BT02165	BT40xER25 - 100	100	42	80072-04
BT02185	BT40xER32 - 70	70		
BT02190	BT40xER32 - 100	100	50	80072-05
BT02200	BT40xER40 - 70	70		
BT02205	BT40xER40 - 100	100	63	80072-06
BT02220	BT40xER50 - 90	90		
BT02225	BT40xER50 - 100	100	78	

■ 特殊規格訂製。Make to order for special specification.

應用

- 本產品可應用於銑刀、鑽頭、鉸刀、絲攻及可夾持任何直柄的刀具及工具

Application

- The product can be applied for end mills, drill bits, drill reamers, taps, and can clamp any straight cutters and tools.



BT 直結式鑽夾頭 Chu CNC Drill Chucks



BT Shank JIS B 6339(MAS 403 BT)
with Collet Chuck DIN 6499

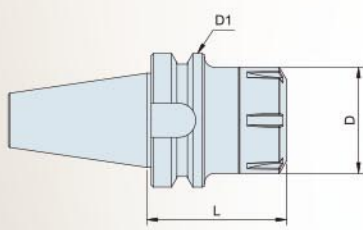

BT刀把 ER立銑式 BT ER Collet Chucks

訂購編號 Order No.	夾持範圍 Range	L	D	D	扳手編號 Spanner No.
BT02230	BT50xER16 - 70	70	28	100	80072-02
BT02240	BT50xER16 - 100	100			
BT02265	BT50xER20 - 70	70	34		80072-03
BT02280	BT50xER20 - 105	105			
BT02310	BT50xER25 - 70	70	42		80072-04
BT02320	BT50xER25 - 105	105			
BT02350	BT50xER32 - 80	80	50		80072-05
BT02355	BT50xER32 - 100	100			
BT02380	BT50xER40 - 80	80	63	80072-06	
BT02410	BT50xER50 - 100	100			
BT02415	BT50xER50 - 120	120	78	80072-07	

■ 特殊規格訂製。Make to order for special specification.

應用

- 本產品可應用於銑刀、鑽頭、銼刀、絲攻及可夾持任何直柄的刀具及工具

Application

- The product can be applied for end mills, drill bits, drill reamers, taps, and can clamp any straight cutters and tools.



BT Shank JIS B 6339(MAS 403 BT)

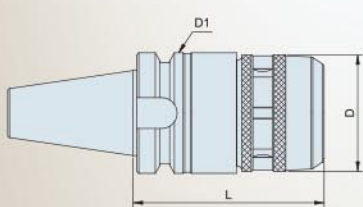

BT強力式立銑刀把 BT Milling Chucks

訂購編號 Order No.	夾持範圍 Range	L	D	D	扳手編號 Spanner No.
BT03005	BT30xC20 - 80	80	52	46	80200-05
BT03015	BT30xC25 - 85	85			80200-10
BT03020	BT40xC20 - 85	85	52	63	80200-05
BT03025	BT40xC20 - 100	100			
BT03030	BT40xC20 - 135	135			
BT03035	BT40xC25 - 90	90	60		80200-10
BT03040	BT40xC25 - 135	135			
BT03055	BT40xC32 - 105	105	69		80200-15
BT03065	BT40xC32 - 135	135			
BT03070	BT50xC20 - 105	105	52	100	80200-05
BT03075	BT50xC20 - 150	150			
BT03080	BT50xC25 - 100	100	60		80200-10
BT03085	BT50xC25 - 150	150			
BT03095	BT50xC32 - 110	110	69		80200-15
BT03100	BT50xC32 - 135	135			
BT03125	BT50xC42 - 110	110	86		80200-20
BT03130	BT50xC42 - 135	135			

■ 特殊規格訂製。Make to order for special specification.

應用

- 此強力銑刀把適用重型及高精密切削

Application

- The milling chuck can be applied for heavy-duty & higher accuracy cutting.

特性

- 內部滾針設計，可減少鎖緊時之摩擦阻力及零件磨耗。
- 防塵設計減少鐵屑掉入以延長使用壽命
- 高夾持力，防止刀具於加工時滑脫，增加刀具壽命。
- 高剛性、高精度

Features

- It is designed with inner rolling needles inside. This design can reduce the friction resistance when tightening and the wear of parts.
- The design of dustproof can prevent iron scrap dropping and extend longevity of chuck.
- The high clamping force is available. The product can prevent the cutting tools from slipping when the users worked it and increase the longevity of cutting tools.
- High rigidity, High precision.

BT 高速刀桿-高速加工專用 BT Chuck for High-Speed Machining



● SK Collet is not included.
不含SK筒夾

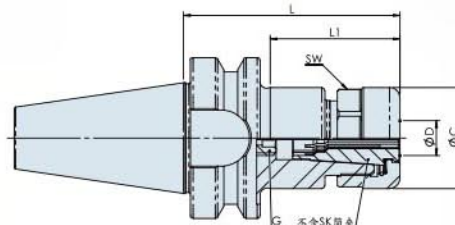

訂購編號 Order No.	夾持範圍 Range	ØD	L	ØC	L1		SW	G	Collet
					Min	Max			
BT25005	BT30-SK 6 - 60L	0.7 ~ 6.0	60	19.7	21	35	18	M6	SKC6
BT25010	BT30-SK 6 - 90L		90						
BT25015	BT30-SK 10 - 60L	1.75 ~ 10.0	60	29	30	50	25	M10	SKC10
BT25020	BT30-SK 10 - 90L		90						
BT25025	BT30-SK 16 - 60L	2.75 ~ 16.0	60	40	40	60	36	M18	SKC16
BT25030	BT30-SK 16 - 90L		90						
BT25033	BT30-SK 16 - 100L		100						
BT25034	BT30-SK 16 - 120L		120						
BT25035	BT30-SK 20 - 60L	4.0 ~ 20.0	60	48.5	40	60	-	M22	SLC20
BT25039	BT30-SK 25 - 85L	16.0 ~ 25.4	85	55	47	80	-	M28	SKC25
BT25040	BT30-SK 25 - 90L		90						
BT25045	BT40-SK 6 - 60L	0.7 ~ 6.0	60	19.7	21	35	18	M6	SKC6
BT25050	BT40-SK 6 - 90L		90						
BT25055	BT40-SK 6 - 120L		120						
BT25060	BT40-SK 10 - 60L	1.75 ~ 10.0	60	29	30	50	25	M10	SKC10
BT25065	BT40-SK 10 - 90L		90						
BT25070	BT40-SK 10 - 120L		120						
BT25075	BT40-SK 10 - 150L		150						
BT25080	BT40-SK 16 - 60L	2.75 ~ 16.0	60	40	50	65	36	M18	SKC16
BT25085	BT40-SK 16 - 90L		90						
BT25088	BT40-SK 16 - 105L		105						
BT25090	BT40-SK 16 - 120L		120						
BT25093	BT40-SK 16 - 135L		135						
BT25095	BT40-SK 16 - 150L		150						
BT25099	BT40-SK 16 - 190L		190						
BT25100	BT40-SK 20 - 60L	4.0 ~ 20.0	60	48.5	47	60	-	M22	SKC20
BT25105	BT40-SK 20 - 90L		90						
BT25110	BT40-SK 20 - 120L		120						
BT25115	BT40-SK 20 - 150L		150						
BT25120	BT40-SK 25 - 90L	16.0 ~ 25.4	90	55	55	75	-	M28	SKC25
BT25125	BT40-SK 25 - 120L		120						
BT25130	BT50-SK 6 - 100L	0.7 ~ 6.0	100	19.7	21	35	18	M6	SKC6
BT25135	BT50-SK 6 - 150L		150						
BT25140	BT50-SK 10 - 100L	1.75 ~ 10.0	100	29	30	50	25	M10	SKC10
BT25145	BT50-SK 10 - 150L		150						
BT25150	BT50-SK 16 - 100L	2.75 ~ 16.0	100	40	40	70	36	M18	SKC16
BT25155	BT50-SK 16 - 150L		150						
BT25160	BT50-SK 16 - 200L		200						
BT25165	BT50-SK 20 - 100L	4.0 ~ 20.0	100	48.5	47	80	-	M22	SKC20
BT25170	BT50-SK 20 - 150L		150						
BT25175	BT50-SK 20 - 200L		200						
BT25180	BT50-SK 25 - 100L		100						
BT25185	BT50-SK 25 - 150L	16.0 ~ 25.4	150	55	50	85	-	M28	SKC25
BT25190	BT50-SK 25 - 200L		200						

■ 特殊規格訂製。Make to order for special specification.

特性

- 藉由SK 螺母(無溝槽)可避免加工時的晃動及降低噪音
- 高剛性
- 高精度
- 高夾持力

Features

- To prevent vibration and reduces noise by SK Nut (notch-free)
- High rigidity
- High accuracy
- High clamping force



BT 油壓刀桿 Hydraulic Tool - Holder

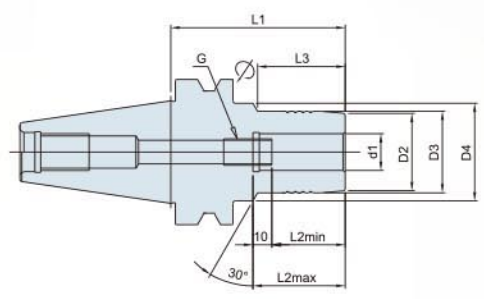

訂購編號 Order No.	規格 Type	d1	D2	D3	D4	L1	L2		L3	G
							Min	Max		
BT36050	BT40-CHY6 - 65	6	26	29	49.5	65	27.5	37.5	23	M5
BT36065	BT40-CHY8 - 65	8	27	30		65	27.5	37.5	23	M6
BT36080	BT40-CHY10 - 65	10	29	32		65	32.5	42.5	23	M8 x 1
BT36095	BT40-CHY12 - 65	12	31	34		65	37.5	47.5	23	M8 x 1
BT36110	BT40-CHY14 - 65	14	33	36		65	37.5	47.5	23	M10 x 1
BT36125	BT40-CHY16 - 65	16	36	40		65	42.5	42.5	23	M10 x 1
BT36140	BT40-CHY18 - 65	18	38	42		65	42.5	42.5	23	M10 x 1
BT36155	BT40-CHY20 - 65	20	40	44		65	42.5	42.5	23	M10 x 1
BT36175	BT40-CHY25 - 100	25	55	60	-	100	51	61	-	M16 x 1
BT36185	BT40-CHY32 - 105	32	58	63	-	105	55	61	-	M16 x 1

■ 特殊規格訂製。Make to order for special specification.

特性

- 重複夾持可靠
- 高剛性
- 高精度因不需使用筒夾
- 高夾持力
- 在使用2.5倍長時 精度為0.003mm

Features

- Reliable for clamping reiteration
- High rigidity
- High accuracy; No collet used
- High clamping force
- Our hydraulic chuck can obtain the run-out within 3µm (T.I.R.) at the position 2.5*d1 from the nose.

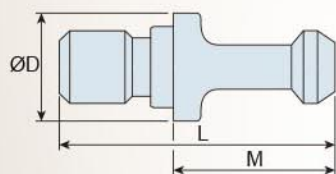

高速全圓螺帽 High Speed Fully Round Nut

訂購編號 Order No.	ØD	L	M
SK10G	30	18.0	M22 x 1.25P
SK13G	35	21.0	M28 x 1.5P
SK16G	40	24.8	M32 x 1.5P
SK20G	50	25.0	M40 x 1.5P
SK36G	55	26.0	M45 x 1.5P

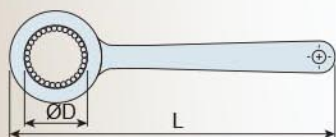

ER-S 全圓扳手 Wrench (PAT.P.)

訂購編號 Order No.	ØD	FIG
S10G	30	145
SK13G	35	155
SK16G	40	175
SK20G	50	195

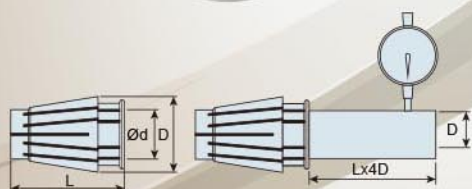

筒夾 Collet

訂購編號 Order No.	D	L	Ød
S10	16	30	2 2.5 3 3.175 3.5 4 4.5 5
			5.5 6 6.5 7 7.5 8 8.5 9 9.5 10
SK13	20	39	3 3.175 3.5 4 4.5 5 5.5 6 6.5
			7 7.5 8 8.5 9 9.5 10 10.5
SK16	25	45	11 11.5 12 12.5 13
			3 3.175 3.5 4 4.5 5 5.5 6 6.5
			7 7.5 8 8.5 9 9.5 10 10.5
			11 11.5 12 12.5 13 13.5 14
SK20	30	50	14.5 15 15.5 16
			3 4 6 8 10 12 14 16 18 20
SK25	36	57	4 6 8 10 12 14 16 18 20 25